

instruments for spine



now available!









gSource®

2 - realistic price

Black aluminum offset handle is designed to provide increased field visualization while providing greater precision and control during microdissection surgery. Rounded corners and flat sides allow for easy rotation with control, stable power and leverage to help reduce unwanted torque.

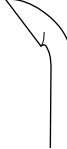
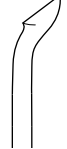
Each instrument is marked on front of handle for easy identification.

See side view picture of gS 33.4202 on right for tip orientation.

								
forward straight (FS)	forward angled (FA)	forward down (FD)	backward straight (BS)	backward angled (BA)	backward down (BD)	cup size #0	cup size #1	cup size #2
gS 33.4200	gS 33.4210	gS 33.4220	gS 33.4230	gS 33.4240	gS 33.4250	#0	#1	#2
gS 33.4201	gS 33.4211	gS 33.4221	gS 33.4231	gS 33.4241	gS 33.4251	#1	#2	
gS 33.4202	gS 33.4212	gS 33.4222	gS 33.4232	gS 33.4242	gS 33.4252	#2		



Micro Lumbar Curettes

9 1/2", offset black aluminum handle

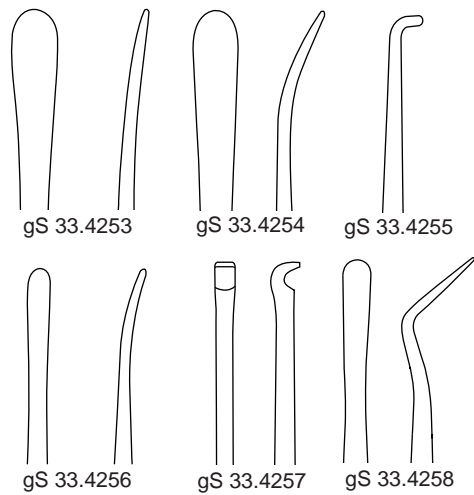

- gS 33.4253** Penfield dissector #1, 6mm slightly curved
- gS 33.4254** Penfield dissector #2, 6mm curved
- gS 33.4255** Nerve hook, 1.3mm
- gS 33.4256** Penfield dissector, #4, 3mm slightly curved
- gS 33.4257** Bone waxer, 2.8mm x 3.0mm
- gS 33.4258** Spine probe, 3.8mm x 11.4mm

Micro Lumbar Instruments

9 1/2", offset black aluminum handle



WL = Working Length

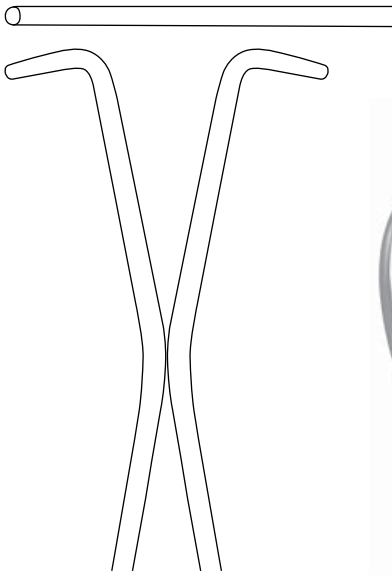

gS 40.8670 7 3/4", 4 1/2" WL

gRetractor, Deep Gelpi

90° angle, 1x1 blunt points
ratchet



gS 40.8608 10 1/2", 3" WL

gS 40.8610 10 1/2", 4" WL

gS 40.8612 10 1/2", 5" WL

Deep Gelpi Retractor

90° angle, 1x1 blunt points
speedlock

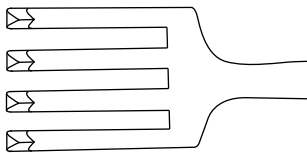

gS 40.8632 10 1/2", 2" WL

gS 40.8638 10 1/2", 3 1/2" WL

gS 40.8640 10 1/2", 4" WL

gS 40.8642 10 1/2", 5" WL

Deep Gelpi Retractor

90° angle, 4 sharp prongs
speedlock

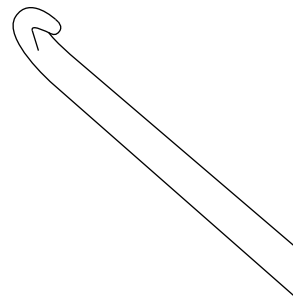

gS 40.8628 12", 3" WL

Deep Gelpi Retractor

45° angle, 1x1 blunt points
speedlock



4 - satisfaction guaranteed

WL = Working Length

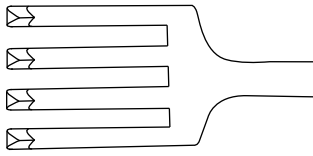

gS 40.8648 13", 3 1/2" WL

Deep Gelpi Retractor

45° angle, 4 sharp prongs
speedlock

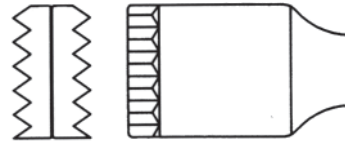

gS 40.3260

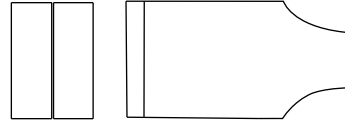

gS 40.3265

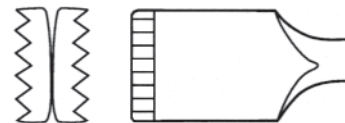

gS 40.3270

gS 40.3260 flat blades with teeth

gS 40.3265 flat blades without teeth

gS 40.3270 concave blades with teeth

Lamina Spreader

10 1/2"
ratchet

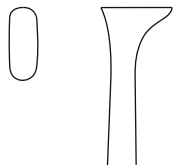

gS 51.4938 9 1/2"

Youngblood Curette

reverse cup 3.8mm

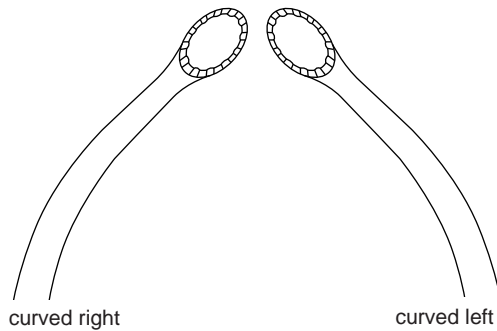

gS 51.4800 17", straight

gS 51.4801 17", curved right

gS 51.4802 17", curved left

Tooth Curette

10mm x 6.5mm oval toothed cup
8" shaft, 9" plastic handle, black



custom options available - 5

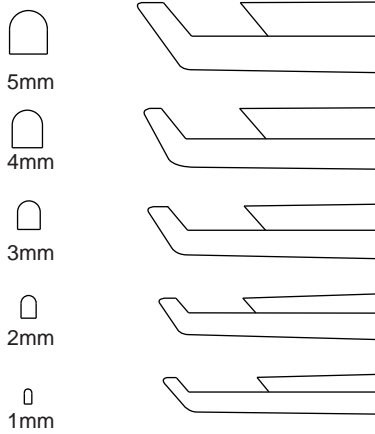

5mm

4mm

3mm

2mm

1mm

Biocompatible silicone coated handles help to prevent slippage and provide a secure and comfortable grip. Available in five standard colors indicated below or custom colors of your choice.

- gS 72.8011** 1mm, brown
- gS 72.8012** 2mm, blue
- gS 72.8013** 3mm, lavender
- gS 72.8014** 4mm, turquoise
- gS 72.8015** 5mm, green

gPunch with silicone coated handle

Ferris-Smith-Kerrison style handle, 5" handle height
8" shaft, forward bite style, regular foot plate

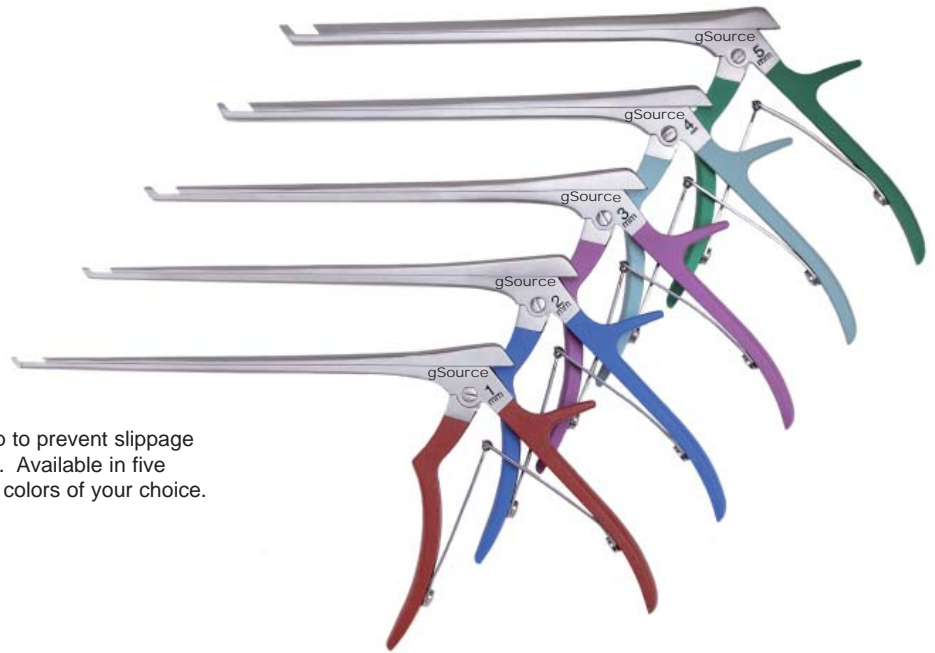

Bends rods up to 6mm with three different cam settings.

Separate reduction ring not required.

Adjustable center cam is spring loaded.



gS 82.7690 19"

gRod Bender, Universal

for rods up to 6mm diameter, detachable handles



Self-locking lever with one-handed quick release.

gS 82.7970 10"

Locking Rod Holder

for 5.5mm diameter rods, self-locking



6 - verified quality

Ø = diameter

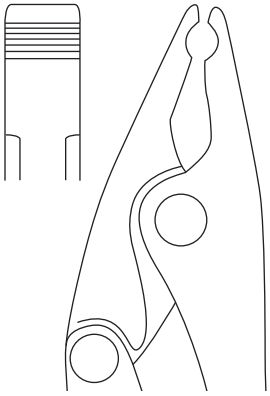

for Ø rods

- gS 82.7551** 4.5mm
- gS 82.7552** 4.75mm
- gS 82.7553** 5.0mm
- gS 82.7555** 5.5mm
- gS 82.7556** 6.0mm
- gS 82.7557** 6.35mm
- gS 82.7558** 6.55mm

Rod Gripper

8 1/2"
adjustable

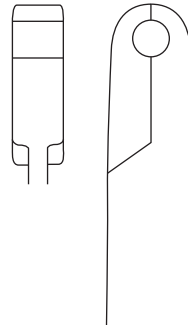

for Ø rods

- gS 82.7740** 4.0mm
- gS 82.7745** 4.76mm
- gS 82.7750** 5.5mm
- gS 82.7760** 6.35mm

Rod Holder

7 1/4" straight
ratchet

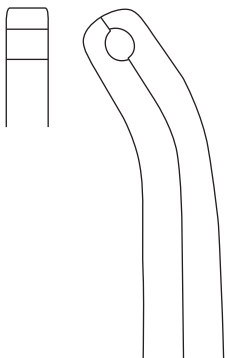

for Ø rods

- gS 82.7840** 4.0mm
- gS 82.7845** 4.5mm
- gS 82.7850** 5.0mm
- gS 82.7855** 5.5mm
- gS 82.7860** 6.35mm

Rod Holder

8 1/2" curved
ratchet

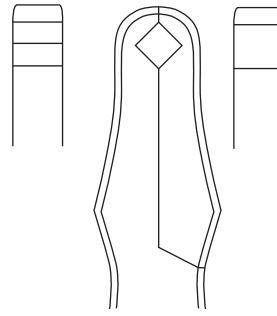

prism

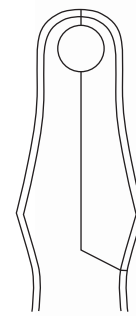

round

for Ø rods

- gS 82.7950** 5.5mm, prism
- gS 82.7955** 5.5mm, round
- gS 82.7960** 6.35mm, round

Rod Holder

10" straight
ratchet

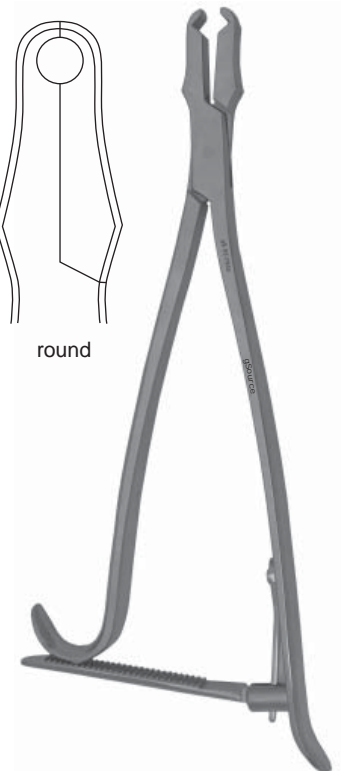

adaptability/flexibility - 7

Shears pins with ease and provides a clean cut without burrs or sharp edges. Handles are ergonomically designed for a comfortable grip and grooved to help prevent slippage.

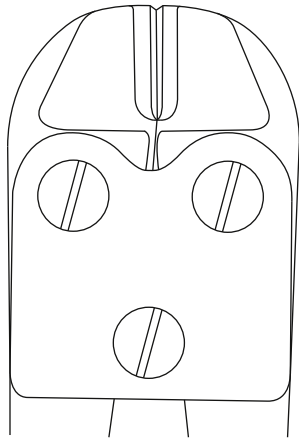

gS 83.8880 9"

gPin Cutter DA Angled

tungsten carbide inserts
max cap 2.8mm

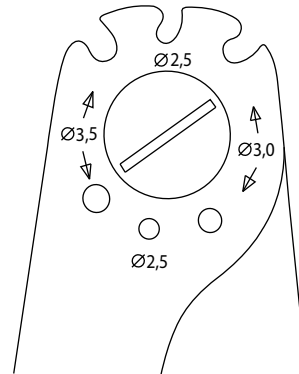

gS 83.9135 11 1/2"

Pin Shears DA

for 2.5mm, 3.0mm, 3.5mm
diameter pins

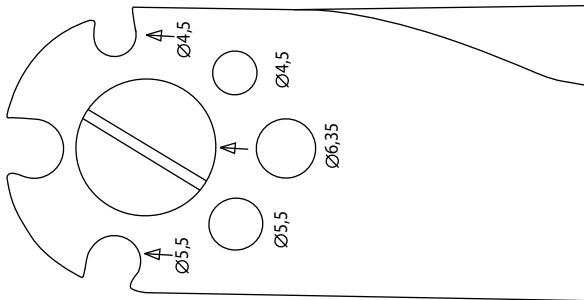

Shears rods with ease and provides a clean cut without burrs or sharp edges. Biocompatible silicone handles help to prevent slippage and provide a secure and comfortable grip.

gS 83.7280 22", non-detachable handles

gS 83.7290 22", detachable handles

gSilicone Rod Shears DA

for 4.5mm, 5.5mm, 6.35mm diameter rods
black silicone handles



gSource

gSource is committed to putting the finest instruments into the hands of surgeons and their teams.

Not all instruments are created equal. Adequate for the job is, in reality, inadequate. A better instrument reduces distractions and facilitates operations. A better instrument helps a surgeon perform at his/her best. A better instrument leads to better results. gSource provides better instruments.

Orthopedic Focus

We are more than a source for quality instrumentation. gSource is an advocate for the orthopedic community. We can be relied upon to provide superior instrumentation for spinal and orthopedic procedures, and do so in a time critical fashion.

gSource Instrument Attributes

Whether crafted from German surgical stainless steel, or machined from U.S. surgical stainless steel, our instruments are recognized by their finely finished surface. They are designed to perform with precise surgical function and are also conceived to be affordable. It is this combination that distinguishes the gSource brand.

gSource Verified Quality

Every gSource instrument must pass detailed Quality Assurance tests before it can be sold. Instruments are tested for quality of material, workmanship, function, pattern consistency and critical dimensions.

Instrument resource

The gSource catalog contains 3,500 instruments primarily used in orthopedic and spinal procedures. To view our catalog or for a quick answer on availability of other patterns, refer to our website at www.apiarymedical.com. Please inquire about the availability of any instrument not shown in the catalog.

Custom Instrumentation

We will create entirely new instruments in a timely and economical manner. For an accurate quotation and delivery schedule, send us a drawing, sketch or sample.

Service First

Your inquiries will be answered quickly and accurately by knowledgeable professionals.



ISO 13485: 2003 Certified
FS 589741
FDA Registered

Trusted Supplier to World Leaders

Many world leaders and innovators in orthopedics and spine have found in gSource a trusted and reliable partner. We provide superior instrumentation in a time-critical fashion and at realistic prices.

Guarantee

All standard instruments are guaranteed for life against manufacturing defects of material and workmanship. Any instrument proving to be defective will be replaced or the purchase price refunded.

- Tungsten carbide inserts are guaranteed for three years. Replaceable parts, other than springs, are guaranteed for one year. Replaceable springs are guaranteed for life against manufacturing defects of material and workmanship.
- This guarantee is void if instruments are altered or not maintained or repaired properly or if they are not used for their intended surgical purpose.
- Any unused instrument may be returned for full credit within 90 days of invoice date.

gSource Advantages

- On-time delivery
- Realistic price
- Verified quality
- German craftsmanship
- Precise U.S. machining
- Orthopedic and spinal focus
- Product development support
- Large selection and inventory
- Adaptability/flexibility
- Superior customer service
- Full satisfaction guarantee

Available from your gSource Distributor:

Apiary Medical, Inc.

12711 Big Bend Way
Valley Center, CA 92082

P 800.561.6692

F 800.561.2160

E cserv@apiarymedical.com

www.apiarymedical.com

Apiarymedical